

HEAT & GLO™



6000 TRSI
Balanced Flue Gas Log Fire

MODEL	HEIGHT		FRONT WIDTH		BACK WIDTH		DEPTH		VIEWING AREA	MJh INPUT		kWh OUTPUT	
	Actual	Framing	Actual	Framing	Actual	Framing	Actual	Framing		NG	LPG	NG	LPG
6000TRSI-AUC	965	980	1043	1070	722	1070	547	560	800 x 475	36	34	7.9	7.5

LEFT SIDE VIEW

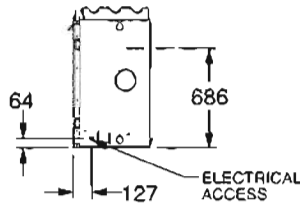
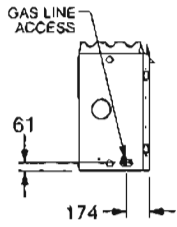

RIGHT SIDE VIEW

FRONT VIEW

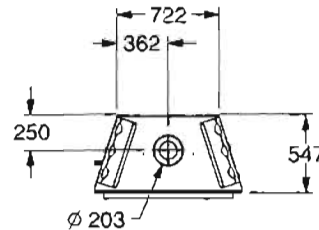
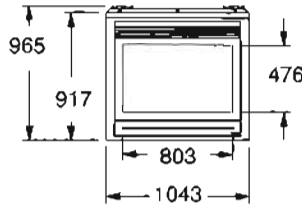

TOP VIEW

FRAMING

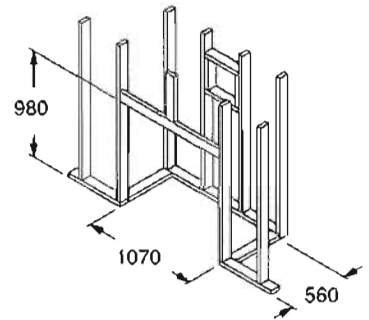

Dimensions above are in millimetres and for reference only. We recommend measuring individual units at installation. Assumes the use of 13mm gyprock.

Refer to installation manual for detailed specifications on installing this product. Heat & Glo reserves the right to update units periodically. The flame and ember appearance may vary based on the type of fuel burned and the venting configuration used. Photos in this brochure may vary in colour and dimension [size] from the actual product.



6000TRSI with all-stainless steel front and 100mm trim



6000TRSI with limestone margins and floating hearth



6000TRSI with 3 sided 100mm black trim

6000 Features

- Top or rear venting options provide installation flexibility
- Zero clearance provides ease of installation and cost savings
- IntelliFire ignition system
- Variable valve allows you to adjust the flame height and heat output
- Realistic ceramic fibre campfire style logs
- Balanced flue technology provides a sealed combustion chamber, maintaining indoor air quality
- Energy saving 79% efficiency with the authenticity of a traditional fire
- Standard dress guard with mesh provides clean lines and safety
- Variable speed fan with auto on/off
- Multi-function remote provides temperature, flame height and start time control, offering true convenience - never again bend down to start your fireplace
- 205mm top or rear venting
- A.G.A. Approval # 5668

IntelliFire Ignition System

Our state-of-the-art ignition system eliminates a continuously burning pilot light and supplies back-up battery power during a power outage, reducing gas consumption and lowering operating costs. Never again will you manually light a pilot or bend down to start your fireplace.

Convenient Operation

Operate the fireplace, adjust the flame height and view the current room temperature all from the comfort of your chair. Whether you wish to have the fire greet you in the morning for that first cup of coffee or warm the room prior to your arrival home at night, simply program the start time and temperature - the Deluxe remote will do the rest. To protect the little ones, each remote is equipped with a child safety start and a wall bracket should you wish to locate the remote out of reach.

Balanced Flue Gas Fireplace

A completely sealed system, Heat & Glo balanced flue gas fireplaces draw 100% of combustion air from the outdoors and exhaust all combustion byproducts back outside, with no effect on indoor air quality. In addition, cold air drafts are eliminated and heat output is maximized. No electricity, power venting or fan are required to operate, eliminating the need for a conventional chimney, and allowing for installation in nearly any room of the home. TR technology, another Heat & Glo invention, allows for venting off the top or rear, providing even greater placement flexibility.

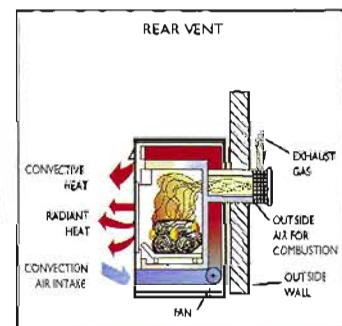
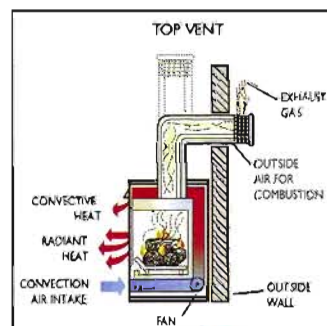

AGNEWS PTY LTD
 376 Swan Street,
 Richmond, VIC 3121
 T 03-9426-2900
 F 03-9426-2999
 E info@agnews.com.au
 W www.agnews.com.au